



WARNING!

SECTIONS  OF THE ASSEMBLY MARKED  ARE NOT SHIELDED AND MUST BE SHIELDED BY AN INTERACTIVE GUARDING SYSTEM. BONDIOLI & PAVESI DECLINES RESPONSIBILITY IF PROPER GUARDS ARE NOT PROVIDED OR MAINTAINED.

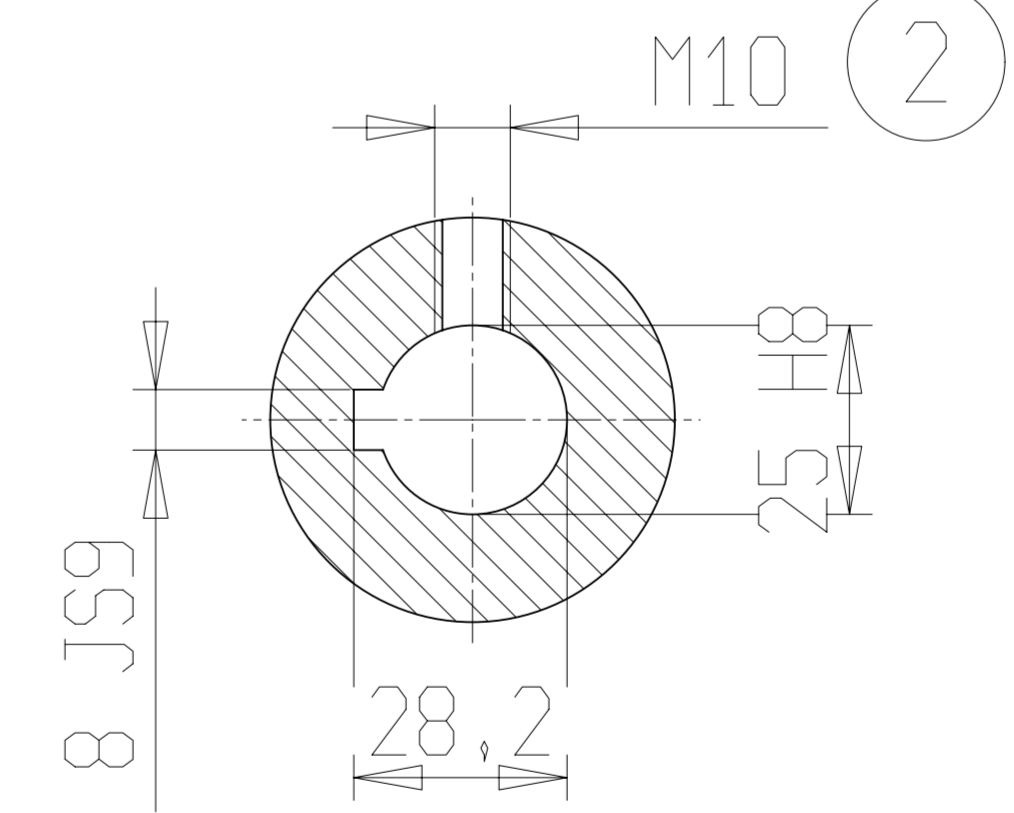
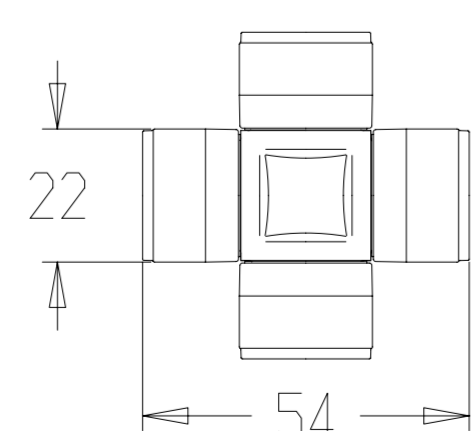
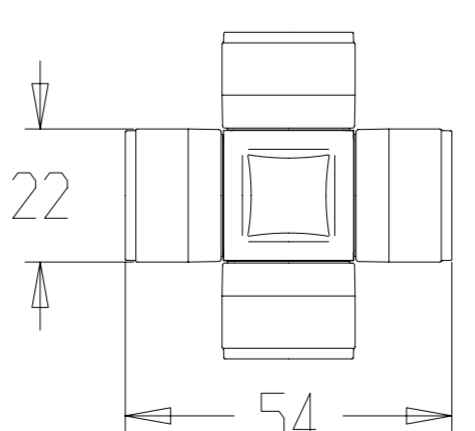
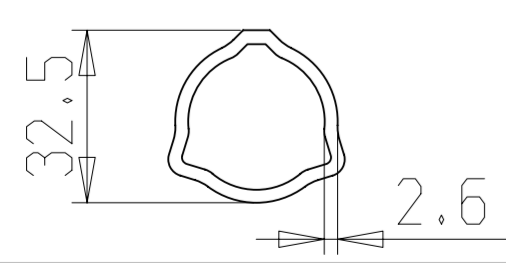
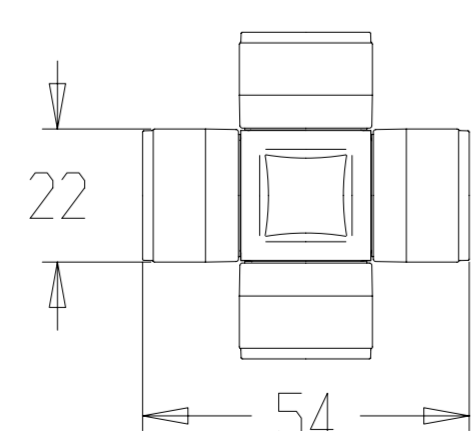
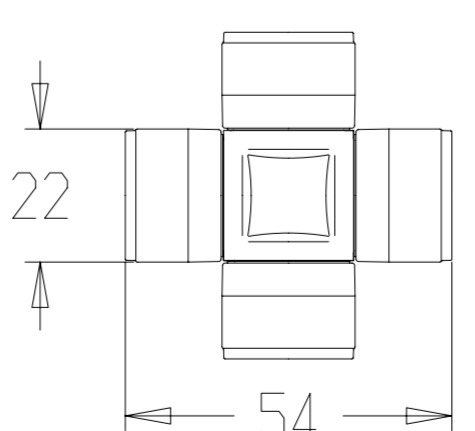
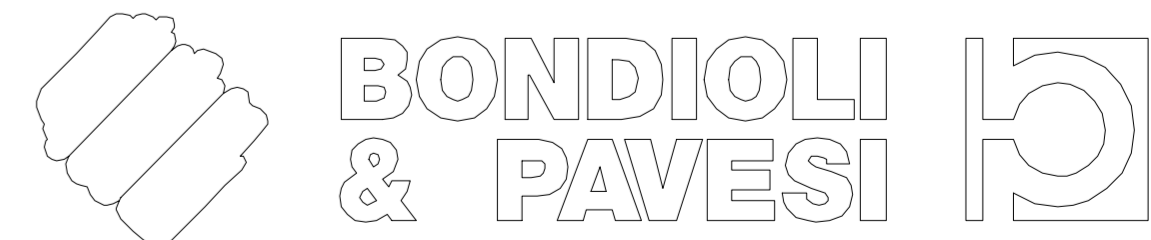
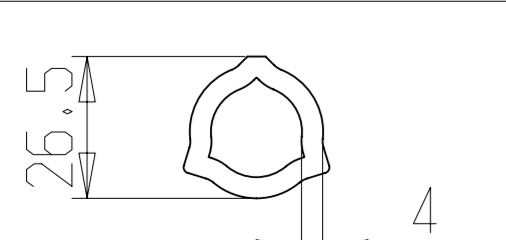

1	CODICE CODE 007	LATO TRATTORE TRACTOR SIDE	LATO MACCHINA IMPLEMENT SIDE	TIPO-TYPE G1	CLIENTE / CUSTOMER 3600502 Dani-Tech A/S	RIF. CLIENTE / CUSTOMER REF.	
2	CODICE CODE 053			DATA / DATE 15/12/2011	DISEGNATO / DESIGNED BY M. Bonetti	TIPO DI MACCHINA / TYPE OF IMPLEMENT	
3	 L=195			LUNGHEZZA MAX IN LAVORO MAX WORKING LENGTH Lw=362	STUDIO / DESIGN TRG1L031002	ORIGINE / ORIGIN 8101031CE007001	
4	 L=240	VELOCITA' MAX MAX SPEED 540 min ⁻¹	M max 750 Nm	LUNGHEZZA MAX TEMPORANEA MAX TEMPORARY LENGTH Lt=370	NOTE / NOTES SPECIALE PER LUNGO SCORRIMENTO	CODICE / CODE 8G1L031CE007001	